

Article number: 2031120M20150B1U

Description: E+G levelling foot
GN 31-120-M20-150-B1-U

Note: U Without nut, Hexagon socket at the top, Wrench flat at the bottom

Measures

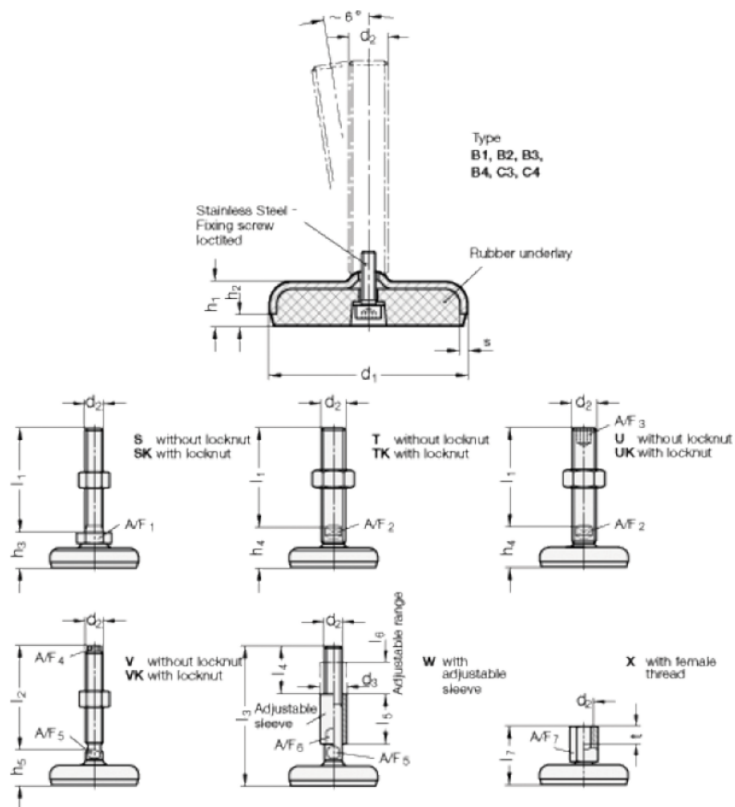

A/F2	= 15	s = 4
A/F3	= 10	
d1	= 120	
d2	= 20	
h1	= 22	
h2	= 6	
h4 +4.0/0	= 39	
l1	= 150	